

**Overview**

Table Top display units with an insulated well made to accommodate Gastronorm GN1/1 size eutectic type packs. Moffat Polar Plates keep food chilled for 2 to 3 hours. Before use, the Polar Plates are charged for 8 to 12 hours in a deep freeze. If longer periods of operation are required, extra Polar Plates can be charged and used in rotation. Holding pre-chilled food by contact cooling perfect for fruit and vegetables, salads, and cold drinks. These short term holding modules offers easy installation and flexibility of use. The polar top units are also fitted with an over head LED illuminated gantry complete with sneeze screen. **Polar :**

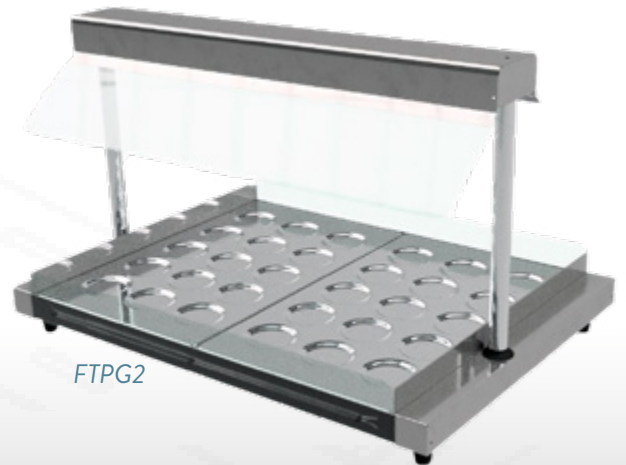

FTPG2

**Key Features:**

- Stylish compact design, with gantry with sneeze screen.
- Unique, heavy duty solid stainless steel fully sealed polar plates.
- Low maintenance.
- Very low power consumption.
- Designed for display where space is at a premium.
- Robust stainless steel construction. Hygienic and easy to clean.
- Supplied with 2m long power cord and 13amp plug [13A 230v 50Hz].
- 3 model lengths in the range holding 2 to 4 GN1/1 Gastronorm type containers.
- Plug and Go, complete with 2 metre long power cable and 13amp plug



FTPG3

**Options:**

- Extra Polar Plates (code: PPGAST)
- Gastronorm pans.



This unit features Moffat's heavy duty GN1/1 size Eutectic type Polar Plates



FTPG2

Model	Capacity No 1/1 GN Pans	Weight (kg)	L x D x H (mm)	Electrical Supply	Power Rating (kw)
FTPG2	2	15	750 x 549 x 475	13amp	0.015
FTPG3	3	20	1078 x 549 x 475	13amp	0.015
FTPG4	4	24	1406 x 549 x 475	13amp	0.015



FTPG3

Diagram of a side view.

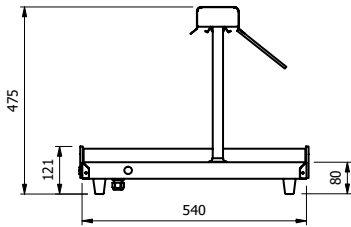

FTPG4

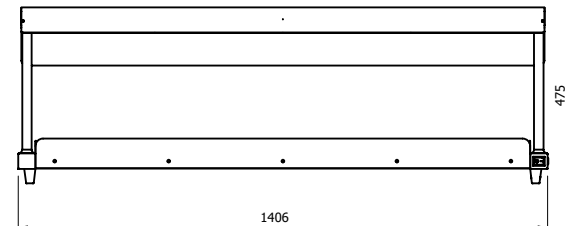
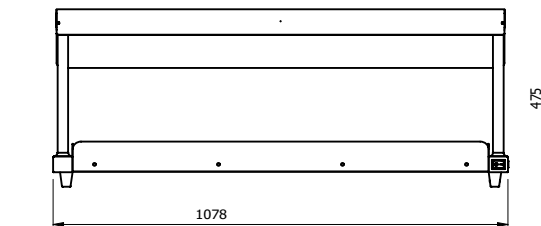
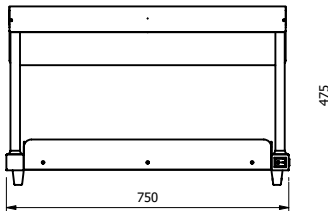
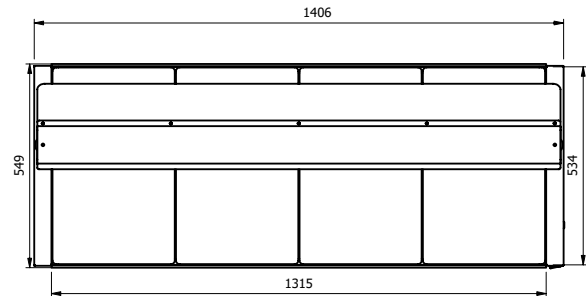
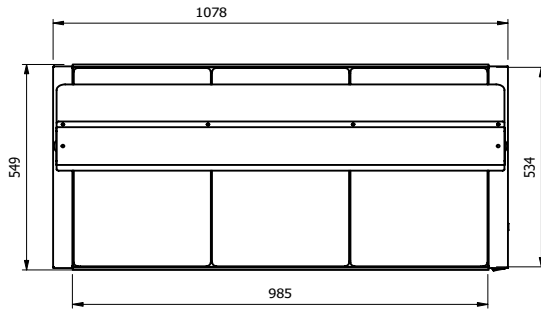
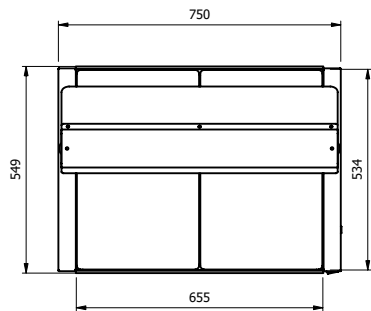

FTPG models

FTPG models

FTPG models



MADE IN BRITAIN

E&R Moffat Ltd.  
Bonnybridge  
FK4 2BS  
Scotland

Find us on:



1963 - 2018

www.ermoffat.co.uk  
+44 (0) 1324 812272  
sales@ermoffat.co.uk