

Moffat Polar Plates keep food chilled for 2 to 3 hours. Before use, the Polar Plates are charged for 8 to 12 hours in a deep freeze.

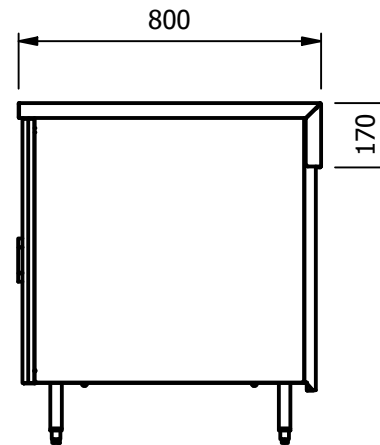
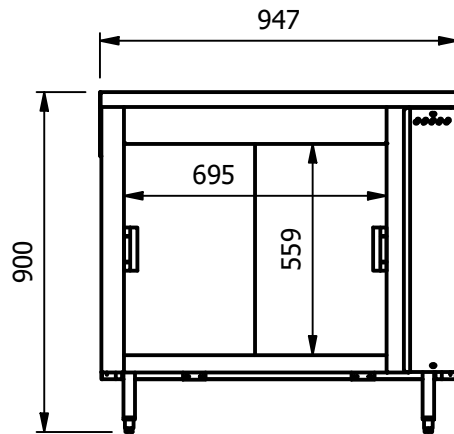

Moffat Specification

Polar Well

The Stainless steel top inset with a Insulated well with contact cooling Polar plates

Dimensions

Width - 947mm
 Depth - 800mm
 Height - 900mm
 Weight - 83kg

Capacity of Storage Cupboard [usable inside space]

Width - 695mm
 Depth - 559mm
 Usable Height Bottom shelf - 210mm
 Usable Height Top Shelf - 195mm

95 off 10" plates stacked
 or
 4 off 1/1GN pans side by side 150mm deep 2 on top 2 on bottom

Materials

1.2mm 304 Grade St/ Steel Top & Supports
 0.7mm 430 Grade St/ Steel Internal Structure
 GN 1/1 Grid Shelves with 30mm x 30mm tube supports

ALL SHEET METAL DIMENSIONS ARE I/S (INSIDE SIZES) (UNLESS OTHERWISE STATED)

ALL DIMENSIONS IN (mm), TOLERANCE = LINEAR ± 0.5mm, ANGULAR ± 0.5mm (OR AS STATED). ALL SHARP EDGES TO BE REMOVED FROM SHEET METAL PARTS

Product	COUNTERS			Product No							
Description	CPW2-8										
Material/Finish	Thickness			Desp/Date							
Legacy P/N	Weight	83kg		Quote No.							
Client				SO Number	N/A		Drawn By	ABB			
Client Project				Approved By			Date	11/05/2022			
E & R MOFFAT LTD, SEABEGS ROAD, BONNYBRIDGE, FK4 2BS, T: +44 (0)1324 812272, E: sales@ermoffat.co.uk, Web: www.ermoffat.co.uk							Scale	1 : 20	Sheet	1 / 2	A4

No reproduction or publication of this drawing may be made, and no article may be manufactured or assembled in accordance with this drawing without prior written consent. This prohibition is a term of any contract relating to this drawing. Rights reserved under the Copyright Act 1956 as amended by the Design Copyright Act 1968.

