



The Catering Equipment
Company



1963 - 2018

Hospital Catering

Serving the Healthcare Industry



www.ermoffat.co.uk

Contents

Moffat offer many solutions;	3
Vgen: model V2GR	4
Vgen: model V2CR	5
Vgen: model V2GG	6
Vgen: model V2GPR	7
Vgen: model V1G	8
Vgen: model V1C	9
Companion Trolleys and Transport Systems	10
Conveyance Trolley	11
Versigen Single Tray Service Trolley System	12
VTSL Units (low height)	14
VTSH Units (high height)	15
Bulk Food Trolleys	12
Hot Carts	13
Conveyor for Hotline Pellet System	14
Single Tray Conveyor System for Hotline, Regeneration or Chillogen	16
Conveyors	18
Dispensers	20
Dispensers	22
Mobile Trolleys	24
Beverage Trolley	26
Toast Warmer	26
Ward Beverage/Breakfast System	27
Ambient TT Range	28
Colour Finishes	30

Moffat offer many solutions;



REGEN Bulk Serve

Food is distributed to ward level in bulk in either a chilled or frozen condition for regeneration using Moffat's state of the art thermal technology that combines both a heating and holding facility for plating at the most convenient time all within the same piece of equipment.

Hot-Cold Split System

A hot and cold regeneration system all on one tray. Trays are assembled centrally with precooked food ready for regeneration on one side and cold food on the other. Food regeneration programming has the patient meal tray ready exactly at the desired time ready to serve at ward level.

Traditional Hot Line

Where food is cooked fresh each day portioned onto trays using a conveyor assembly line method and with the use of insulated trayware distributed using ambient meal delivery trolleys to the patients. By using insulated plate domes and bases food temperature will be retained for a maximum of 30 minutes from time of portioning.



Hot Line Single tray system

Hot and cold system all on one tray. Food is cooked fresh each day and portioned onto the single trays using a conveyor assembly line. The trays are loaded into the tray serve trolley and are given a super boost before travelling to the ward level. There the trolleys can be connected to a 13 amp socket keeping the hot side hot and the cold side cold until ready to serve.

Hot Line with High Heat Store Pellets

A more robust temperature maintenance system compared with Traditional Hot Line using wax filled heat store pellets and pellet underliners that lengthen the time of temperature retention to 60 minutes from time of portioning.

Bulk Serve

Food is cooked fresh daily and distributed to each ward in insulated containers. Special bulk serve ward level mobile service counters provide the perfect meal plating centre. The service units will provide both hot and refrigerated sections and can be manufactured to suit various ward sizes and menu variations.



Our Green Thinking logo highlights innovation in our manufacturing which makes our products environmentally conscious through energy savings, sustainability and efficiency in production

Vgen: model V2GR

Designed specifically for the cooking/regeneration and serving of fresh, chilled or frozen bulk food. This unit allows customer choice at the point of consumption. Useful for multi-food portioning and multi-food distribution.

Featuring E & R Moffat's pioneering, three-zone, multi-heat, control oven system. VGen enables total control of food temperature, texture and presentation. Complete with an accurately controlled, forced air refrigeration compartment and illuminated self-regulating hot-top.



Operating modes:

Cook & Serve	Use in the same manner as a traditional convection oven
Cook Chilled	Regeneration of chilled bulk food [0°C to 8°C optimum 5°C] to above 82°C
Cook Frozen	Regeneration of frozen bulk food [-6°C to -25°C optimum -18°C] to above 82°C
Keep Hot	Holding hot bulk food above 63°C, compartment controlled at 90°C
Keep Chilled	Holding chilled bulk food below 5°C, compartment controlled between 0°C & 5°C
Serve Hot	Hot-top serving area controlled at 90°C

Key Features:

- LED display lighting
- Coloured LED operation indication (LEDs flash to signal warning when oven door is open)
- 3 fully controllable oven zones in a landscape configuration
- One-piece, neo-ceram, thermo-panel hot top
- Steam evac & oven door air curtain
- Touch screen, total control system with multi-function display & simplistic program choice
- Each compartment supplied with removable shelf hangers
- Wide choice of coloured front & end panels (standard colour is Dobel Grey)
- Both refrigeration & oven use Moffat's renowned multi-fan recirculating air system
- R290 Refrigeration with clean-free, fan-assisted condenser
- Lift-up hob for easy servicing

Benefits:

- Complete with 2m long cable & 13amp plug, as standard
- Food probe & HACCP compliant data recording system
- 24/7 program timer
- Keep hot & boost functions
- Three-program, total control system
- Easily manoeuvrable, lightweight & compact design



MODEL	Weight kg	Dimensions L x D x H mm	Power Rating kw	Oven Capacity Litre	Grid shelf positions	Fridge Capacity Litre	Grid shelf positions	Shelf Pitch mm	Hot Top Capacity L x D mm
V2GR	175	1308 x 740 x 1338	2.9	98	8 (8 supplied)	98	8 (4 supplied)	71	1210 x 590

Optional Extras

- V1TS Size 1 Tray Slide
- V2TS Size 2 Tray Slide
- CC3 3 cutlery cups to suit trayslides
- VES End Shelf
- VWR End shelf with waste bag holder on operators' right hand
- VWL End shelf with waste bag holder on operators' left hand
- VTB Tow Bar and Hitch
- VPS Portrait Rod Shelf
- VLS Landscape Rod Shelf

- V4CP 4GN Cassette [Portrait]
- V8CP 8GN Cassette [Portrait]
- V8CL 8GN Cassette [landscape]
- V1D Cassette Dolly for V1G & V1C Trolley
- V2D Cassette Dolly for V2GR, V2CR & V2GPR Trolley
- V3D Cassette Dolly for V2GG Trolley
- VC8 Cover for 8GN Cassette Portrait or Landscape type
- VC4 Cover for 4GN Cassette

Vgen: model V2CR

Designed specifically for the regeneration and serving of chilled bulk food. Using “Chillogen”, this VGen model allows refrigeration and regeneration in one holding space. First keep food chilled, then simply switch to regeneration manually/automatically without further handling of food. VGen then automatically holds food at the correct serving temperature until you are ready to serve.

Featuring E & R Moffat’s pioneering, three-zone, multi-heat, control oven system. VGen enables total control of food temperature, texture and presentation. Complete with an accurately controlled, illuminated, self-regulating hot-top. All in one convenient unit.



Operating modes:

Keep Chilled	Holding chilled bulk food below 5°C, compartment controlled between 0°C & 5°C
Cook Chilled	Regeneration of chilled bulk food [0°C to 8°C optimum 5°C] to above 82°C
Keep Hot	Holding hot bulk food above 63°C, compartment controlled at 90°C
Serve Hot	Hot-top serving area controlled at 90°C

Key Features:

- LED display lighting
- Coloured LED operation indication (LEDs flash to signal warning when oven door is open)
- 3 fully controllable oven zones in a landscape configuration
- One-piece, neo ceram, thermo-panel hot-top
- Steam evac & oven door air curtain
- Touch screen, total control system with multi-function display & simplistic program choice
- Each compartment supplied with removable shelf hangers
- Wide choice of coloured front & end panels (standard colour is Dobel Grey)
- Oven with Moffat’s renowned, multi-fan, recirculating air system
- Lift-up hob for easy servicing
- Lockable doors open out 270°
- 4 x precision castors, 2 swivel with breaks & 2 fixed

Benefits:

- Complete with 2m long cable & 13amp plug, as standard
- Food probe & HACCP compliant data recording system
- 24/7 program timer
- Keep hot & boost functions
- 3 program total control system
- Easily manoeuvrable, lightweight & compact design



MODEL	Weight kg	Dimensions L x D x H mm	Power Rating kw	Oven Capacity Litre	Grid shelf positions	Fridge Capacity Litre	Grid shelf positions	Shelf Pitch mm	Hot Top Capacity L x D mm
V2CR	170	1308 x 740 x 1338	2.9	98	8 (8 supplied)	98	8 (4 supplied)	71	1210 x 590

Optional Extras

- V1TS Size 1 Tray Slide
- V2TS Size 2 Tray Slide
- CC3 3 cutlery cups to suit trayslides
- VES End Shelf
- VWR End shelf with waste bag holder on operators’ right hand
- VWL End shelf with waste bag holder on operators’ left hand
- VTB Tow Bar and Hitch
- VPS Portrait Rod Shelf
- VLS Landscape Rod Shelf

- V4CP 4GN Cassette [Portrait]
- V8CP 8GN Cassette [Portrait]
- V8CL 8GN Cassette [landscape] P
- V1D Cassette Dolly for V1G & V1C Trolley
- V2D Cassette Dolly for V2GR, V2CR & V2GPR Trolley
- V3D Cassette Dolly for V2GG Trolley
- VCB Cover for 8GN Cassette Portrait or Landscape type
- VC4 Cover for 4GN Cassette

Vgen: model V2GG

Designed specifically for the cooking/regeneration and serving of fresh, chilled or frozen bulk food. This unit allows customer choice at the point of consumption. Useful for multi-food portioning and multi-food distribution.

Featuring E & R Moffat's pioneering, three-zone, multi-heat, control oven system. VGen enables total control of food temperature, texture and presentation. Complete with an accurately controlled, forced air, illuminated, self-regulating hot-top.

Operating modes:

Cook & Serve	Use in the same manner as a traditional convection oven
Cook Chilled	Regeneration of chilled bulk food [0°C to 8°C optimum 5°C] to above 82°C
Cook Frozen	Regeneration of frozen bulk food [-6°C to -25°C optimum -18°C] to above 82°C
Keep Hot	Holding hot bulk food above 63°C, compartment controlled at 90°C
Serve Hot	Hot-top serving area controlled at 90°C



Key Features:

- LED display lighting
- Coloured LED operation indication (LEDs flash to signal warning when oven door is open)
- 3 fully controllable oven zones in a portrait configuration
- One-piece, neo-ceram, thermo-panel hot top
- Steam evac & oven door air curtain
- Touch-screen, total control system with multi-function display & simplistic program choice
- Each compartment supplied with removable shelf hangers
- Wide choice of coloured front & end panels (standard colour is Dobel Grey)
- Oven with Moffat's renowned, multi-fan, recirculating air system
- Lift-up hob for easy servicing
- Lockable doors open out 270°
- 4 x precision castors, 2 swivel with breaks and 2 fixed

Benefits:

- Complete with 2m long cable and 32amp, single-phase commando plug, as standard
- Food probe & HACCP compliant data recording system
- 24/7 program timer
- Keep hot & boost functions
- 3-program total control system
- Easily manoeuvrable, lightweight & compact design



MODEL	Weight kg	Dimensions L x D x H mm	Power Rating kw	Left-Hand Oven Capacity Litre	Grid shelf positions	Right-Hand Oven Capacity Litre	Grid shelf positions	Shelf Pitch mm	Hot Top Capacity L x D mm
V2GG	160	1308 x 740 x 1338	5.8	98	8 (8 supplied)	98	8 (8 supplied)	71	1210 x 590

Optional Extras

V1TS Size 1 Tray Slide
 V2TS Size 2 Tray Slide
 CC3 3 cutlery cups to suit trayslides
 VES End Shelf
 VWR End shelf with waste bag holder on operators' right hand
 VWL End shelf with waste bag holder on operators' left hand
 VTB Tow Bar and Hitch
 VPS Portrait Rod Shelf
 VLS Landscape Rod Shelf

V4CP 4GN Cassette [Portrait]
 V8CP 8GN Cassette [Portrait]
 V8CL 8GN Cassette [landscape]
 V1D Cassette Dolly for V1G & V1C Trolley
 V2D Cassette Dolly for V2GR, V2CR & V2GPR Trolley
 V3D Cassette Dolly for V2GG Trolley
 VC8 Cover for 8GN Cassette Portrait or Landscape type
 VC4 Cover for 4GN Cassette

Vgen: model V2GPR

Designed specifically for the cooking/regeneration and serving of fresh, chilled or frozen bulk food. This unit allows customer choice at the point of consumption. Useful for multi-food portioning and multi-food distribution.

Featuring E & R Moffat's pioneering, three-zone, multi-heat, control oven system. VGen enables total control of food temperature, texture and presentation. Complete with an accurately controlled, forced air refrigeration compartment and illuminated, self-regulating hot-top.



Operating modes:

Cook & Serve	Use in the same manner as a traditional convection oven
Cook Chilled	Regeneration of chilled bulk food [0°C to 8°C optimum 5°C] to above 82°C
Cook Frozen	Regeneration of frozen bulk food [-6°C to -25°C optimum -18°C] to above 82°C
Keep Hot	Holding hot bulk food above 63°C, compartment controlled at 90°C
Keep Chilled	Holding chilled bulk food below 5°C, compartment controlled between 0°C & 5°C
Serve Hot	Hot-top serving area controlled at 90°C
Plate Warmer	Heats up and holds plates, controlled at 40°C

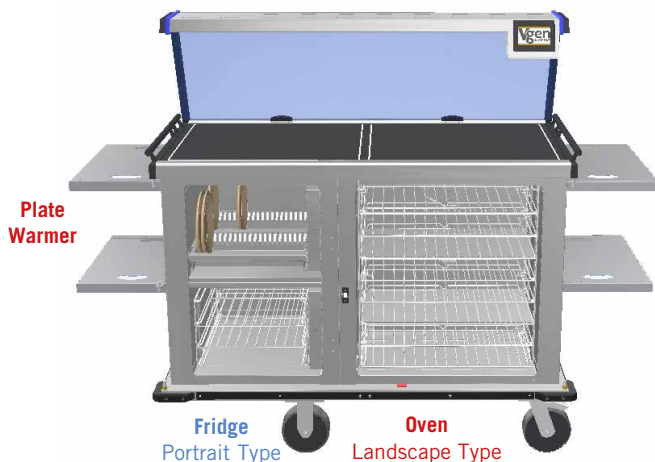

Key Features:

- LED display lighting with coloured LED operation indication (LEDs flash to signal warning when oven door is open)
- 3 fully controllable oven zones in a landscape configuration
- One-piece, neo ceramic, thermo-panel hot top
- Steam evac & oven door air curtain
- Touch screen, total control system with multi-function display & simplistic program choice
- Each compartment supplied with removable shelf hangers
- Wide choice of coloured front and end panels (standard colour is Dobel Grey)
- Both refrigeration and oven use Moffat's renowned multi-fan recirculating air system
- R290 Refrigeration with clean-free, fan assisted condenser
- Lift-up hob for easy servicing
- Lockable doors open out 270°
- 4 x precision castors, 2 swivel with breaks and 2 fixed
- Heavy duty, fully extendable plate rack, holds 40 x 9" plates (230mm diameter)

Benefits:

- Complete with 2m long cable and 13amp plug, as standard
- Food probe & HACCP compliant data recording system
- 24/7 program timer
- Keep hot & boost functions
- 3 program total control system
- Easily manoeuvrable, lightweight & compact design
- Handy plate rack system

MODEL	Weight kg	Dimensions L x D x H mm	Power Rating kw	Oven Capacity Litre	Grid shelf positions	Fridge Capacity Litre	Grid shelf positions	Plate Capacity	Shelf Pitch mm	Hot Top Capacity L x D mm
V2GPR	175	1308 x 740 x 1338	2.9	98	8 (8 supplied)	49	4 (2 supplied)	40 (9")	71	1210 x 590

Optional Extras

- V1TS Size 1 Tray Slide
- V2TS Size 2 Tray Slide
- CC3 3 cutlery cups to suit trayslides
- VES End Shelf
- VWR End shelf with waste bag holder on operators' right hand
- VWL End shelf with waste bag holder on operators' left hand
- VTB Tow Bar and Hitch
- VPS Portrait Rod Shelf
- VLS Landscape Rod Shelf

- V4CP 4GN Cassette [Portrait]
- V8CP 8GN Cassette [Portrait]
- V8CL 8GN Cassette [landscape]
- V1D Cassette Dolly for V1G & V1C Trolley
- V2D Cassette Dolly for V2GR, V2CR & V2GPR Trolley
- V3D Cassette Dolly for V2GG Trolley
- VCS Cover for 8GN Cassette Portrait or Landscape type
- VCS4 Cover for 4GN Cassette

Vgen: model V1G

Designed specifically for the cooking/regeneration and serving of fresh, chilled or frozen bulk food. This unit allows customer choice at the point of consumption. Useful for multi-food portioning and multi-food distribution.

Featuring E & R Moffat's pioneering, three-zone, multi-heat, control oven system. VGen enables total control of food temperature, texture and presentation. Complete with an accurately controlled, illuminated, self-regulating hot-top.

Operating modes:

Cook & Serve	Use in the same manner as a traditional convection oven
Cook Chilled	Regeneration of chilled bulk food [0°C to 8°C optimum 5°C] to above 82°C
Cook Frozen	Regeneration of frozen bulk food [-6°C to -25°C optimum -18°C] to above 82°C
Keep Hot	Holding hot bulk food above 63°C, compartment controlled at 90°C
Serve Hot	Hot-top serving area controlled at 90°C



Key Features:

- LED display lighting
- Coloured LED operation indication (LEDs flash to signal warning when oven door is open)
- 3 fully controllable oven zones in a landscape configuration
- One-piece, neo ceram, thermo-panel hot top
- Steam evac & oven door air curtain
- Touch-screen, total control system with multi-function display & simplistic program choice
- Each compartment supplied with removable shelf hangers
- Wide choice of coloured front & end panels (standard colour is Dobel Grey)
- Oven with Moffat's renowned, multi-fan, recirculating air system
- Lift-up hob for easy servicing
- Lockable doors open out 270°
- 4 x precision castors, 2 swivel with breaks and 2 fixed

Benefits:

- Complete with 2m long cable and 13amp plug, as standard
- Food probe & HACCP compliant data recording system
- 24/7 program timer
- Keep hot & boost functions
- 3-program total control system
- Easily manoeuvrable, lightweight & compact design

MODEL	Weight kg	Dimensions L x D x H mm	Power Rating kw	Oven Capacity Litre	Grid shelf positions	Shelf Pitch mm	Hot Top Capacity L x D mm
V1G	120	798 x 740 x 1338	2.9	98	8 (8 supplied)	71	700 x 590

Optional Extras

- V1TS** Size 1 Tray Slide
- V2TS** Size 2 Tray Slide
- CC3** 3 cutlery cups to suit trayslides
- VES** End Shelf
- VWR** End shelf with waste bag holder on operators' right hand
- VWL** End shelf with waste bag holder on operators' left hand
- VTB** Tow Bar and Hitch
- VPS** Portrait Rod Shelf
- VLS** Landscape Rod Shelf

- V4CP** 4GN Cassette [Portrait]
- V8CP** 8GN Cassette [Portrait]
- V8CL** 8GN Cassette [landscape]
- V1D** Cassette Dolly for V1G & V1C Trolley
- V2D** Cassette Dolly for V2GR, V2CR & V2GPR Trolley
- V3D** Cassette Dolly for V2GG Trolley
- VC8** Cover for 8GN Cassette Portrait or Landscape type
- VC4** Cover for 4GN Cassette

Vgen: model V1C

Designed specifically for the cooking/regeneration and serving of fresh, chilled or frozen bulk food. This unit allows customer choice at the point of consumption. Useful for multi-food portioning and multi-food distribution.

Featuring E & R Moffat's pioneering, three-zone, multi-heat, control oven system. VGen enables total control of food temperature, texture and presentation. Complete with an accurately controlled, illuminated, self-regulating hot-top.



Operating modes:

Cook & Serve	Use in the same manner as a traditional convection oven
Cook Chilled	Regeneration of chilled bulk food [0°C to 8°C optimum 5°C] to above 82°C
Keep Hot	Holding hot bulk food above 63°C, compartment controlled at 90°C
Serve Hot	Hot-top serving area controlled at 90°C



Key Features:

- LED display lighting
- Coloured LED operation indication (LEDs flash to signal warning when oven door is open)
- 3 fully controllable oven zones in a landscape configuration
- One-piece, neo ceram, thermo-panel hot top
- Steam evac & oven door air curtain
- Touch screen, total control system with multi-function display & simplistic program choice
- Each compartment supplied with removable shelf hangers
- Wide choice of coloured front & end panels (standard colour is Dobel Grey)
- Oven with Moffat's renowned, multi-fan, recirculating air system
- Lift-up hob for easy servicing
- Lockable doors open out 270°
- 4 x precision castors, 2 swivel with breaks & 2 fixed

Benefits:

- Complete with 2m long cable & 13amp plug, as standard
- Food probe & HACCP compliant data recording system
- 24/7 program timer
- Keep hot & boost functions
- 3 program total control system
- Easily manoeuvrable, lightweight & compact design

MODEL	Weight kg	Dimensions L x D x H mm	Power Rating kw	Oven Capacity Litre	Grid shelf positions	Shelf Pitch mm	Hot Top Capacity L x D mm
V1C	130	798 x 740 x 1338	2.9	98	8 (8 supplied)	71	700 x 590

Optional Extras

V1TS Size 1 Tray Slide

V2TS Size 2 Tray Slide

CC3 3 cutlery cups to suit trayslides

VES End Shelf

VWR End shelf with waste bag holder on operators' right hand

VWL End shelf with waste bag holder on operators' left hand

VTB Tow Bar and Hitch

VPS Portrait Rod Shelf

VLS Landscape Rod Shelf

V4CP 4GN Cassette [Portrait]

V8CP 8GN Cassette [Portrait]

V8CL 8GN Cassette [landscape]

V1D Cassette Dolly for V1G & V1C Trolley

V2D Cassette Dolly for V2GR, V2CR & V2GPR Trolley

V3D Cassette Dolly for V2GG Trolley

VC8 Cover for 8GN Cassette Portrait or Landscape type

VC4 Cover for 4GN Cassette

Companion Trolleys and Transport Systems

To complement your Versigen Bulk Food Trolley when it is based at ward level or a dedicated food service point. For the movement and service of food, cutlery, crockery trays and all things that may be required to back up your Versigen Bulk Food Service.

Light enough for one person to wheel around the ward after the meal to collect all the soiled trays, cutlery etc. and return to the wash area.

As circumstances vary in each situation these trolleys are designed to suit your exact requirements. Based around a standard design which can be made shorter, longer, higher, whatever it needs to carry the items you want at the service point.

Open Companion Trolley

Open companion trolley for the transfer of plates, trays, cutlery etc from the kitchen to the service area. PLUS dirties return to the wash up area.



Model VCP3
Companion trolley and optional hook on waste bin

Model VCP3E
Companion trolley with customised extended legs, containers for cutlery and optional hook on waste bin

MODEL	Dimensions L x D x H mm	No. Shelves
VCP2	880 x 680 x 925	2
VCP3	880 x 680 x 925	3
VCP2E	880 x 680 x 1180	2
VCP3E	880 x 680 x 1180	3

Optional Extras

WESB Hook on Waste Bin

includes two large plastic containers

Models ending with

“E” = extended legs with additional four plastic pans for cutlery etc.

Transfer Dolly

Cassettes can be loaded in the kitchen, then complete with the temperature retention cover, conveyed on the Transfer Dolly to ward/service area where they are inserted into the oven/ refrigerated compartments ready for regeneration/refrigeration.



V4CP 4GN Cassette, 8GN Cassette



V8CL



V8CP

MODEL	Dimensions L x D x H mm	Type of Cassette
V4CP	350 x 500 x 250	4GN Cassette (Portrait)
V8CP	350 x 500 x 600	8GN Cassette (Portrait)
V8CL	550 x 300 x 600	8GN Cassette (Landscape)

Optional Extras

V4CP 4GN Cassette [Portrait]

V8CP 8GN Cassette [Portrait]

V8CL 8GN Cassette [landscape]

V1D Cassette Dolly for V1G & V1C Trolley

V2D Cassette Dolly for V2GR, V2CR & V2GPR Trolley

V3D Cassette Dolly for V2GG Trolley

VC8 Cover for 8GN Cassette Portrait or Landscape type

VC4 Cover for 4GN Cassette

Conveyance Trolley

Model CA13

Versatile food conveyance trolley, suitable for the distribution of food from a food prep area to multiple points of service. Ideal for hospitals and other catering facilities providing a thermally insulated transport between main kitchen and wards satellite kitchens. Designed to compliment the V-Gen range of trolleys chilled food can be held/prepared in a cold room and moved up to and loaded into the Re-gen Oven.

- Can hold up to thirteen Gn1/1 Trays or Gastronorm pans 65mm deep
- Lightweight and easy to move, made from a combination of Stainless Steel and Anodised Alloy
- Hygienic and easy to clean
- Push Pull handles and corner bumper protection
- Wide range of colour choice
- 13 shelf positions 4 shelves supplied as standard
- All round Galley rail on top for added storage
- Door opens 270°
- Robust door slam catch / handle
- Accommodates Eutectic Polar plates for longer storage periods

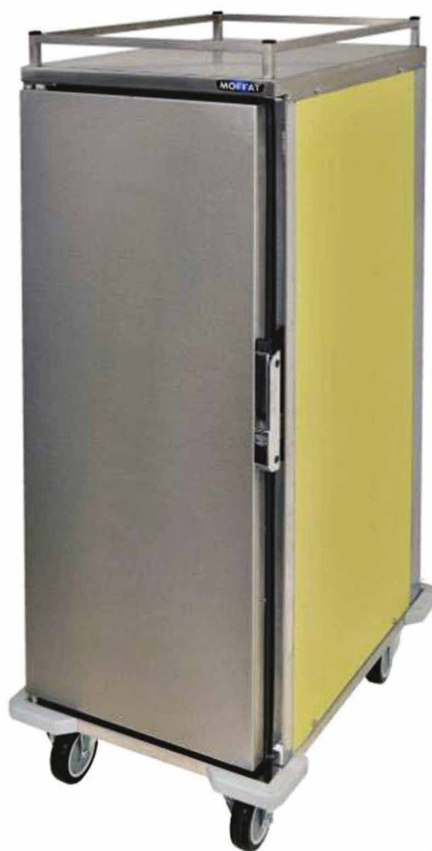

MODEL	Weight kg	Dimensions L x D x H mm
CA13	48	700 x 495 x 1310

Optional Extras

PPGAST Polar Plates

Bulk Food Trolleys

These trolleys are designed for the distribution of bulk food meals in 1/1 gastronorm containers.

This versatile range can be supplied as an ambient trolley, or with keep hot compartments (BF2, BF3), refrigeration compartments or with a combination of these. With the plate converter fitted (either factory or retro) the PM range can accommodate 16 plated meals in each compartment.

The BF2B, BF2BR, BF3B and BF3BR also feature Bains Marie with covers to the top of the unit along with the combinations of ambient, heated or refrigerated compartments below.

Capacity

- Each compartment in a BF2 can hold 8 1/1 gastronorm containers 65mm deep.
- The BF2B Trolley has a bain marie well in the top that can hold 2 x 1/1 gastronorm up to 150mm deep, the bain marie is fitted with hinged covers which convert to service areas when opened out. Each compartment in a BF2B can hold 6 1/1 Gastronorm containers 65mm deep

Controls

- There is a digital control temperature and display to each compartment pre wired with a 13amp plug and cable.

Hygiene and Cleaning

- The Trolley is manufactured from 304 stainless steel throughout and all the internal compartments are formed into a one piece unit leaving a crevice free easy clean interior.
- The unit is also fitted with four 150mm diameter precision bearing castors two with brakes for easy manoeuvring.

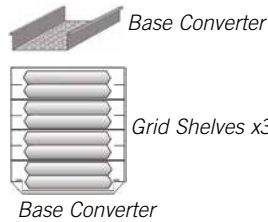

Conversion kit to transform compartment to accommodate plated meals (PM).



Options

- Additional Bulk Food/Plated Meal grid shelf.
- VGEN tow bar.
- Triple tube trayslide.
- Plain trayslide with cutlery cut outs.
- VGEN end shelf.
- Gantry (for plain top units only).
- All round tubular gallery rail to plain top.



MODEL	Weight kg	Dimensions L x D x H mm	Capacity No. of Plated Meals	Power Rating kw	Compartment Keep Hot	Compartment Refrigeration	Plain Top	Bainmarie Top
PM2	110	1195 x 710 x 960	32 Hot	1.5	2x8 GN	-	✓	
PM2R	136	1195 x 710 x 960	16 Hot/16 Cold	1.4	1x8 GN	1x8 GN	✓	
PM3	128	1635 x 710 x 960	48	2.25	3x8 GN	-	✓	
PM3R	150	1635 x 710 x 960	32 Hot/16 Cold	2.9	2x8 GN	1x8 GN	✓	
BF2	100	1195 x 710 x 960	-	1.5	2x8 GN	-	✓	
BF2R	126	1195 x 710 x 960	-	1.4	1x8 GN	1x8 GN	✓	
BF2B	114	1195 x 710 x 960	-	2.5	2x6 GN	-		✓
BF2BR	140	1195 x 710 x 960	-	2.4	1x6 GN	1x6 GN		✓
BF2RR	130	1195 x 710 x 960	-	0.75	-	2x6 GN	✓	
BF3	140	1635 x 710 x 960	-	2.25	3x8 GN	-	✓	
BF3R	166	1635 x 710 x 960	-	2.9	2x8 GN	1x8 GN	✓	
BF3B	155	1635 x 710 x 960	-	2.9	3x6 GN	-		✓
BF3BR	180	1635 x 710 x 960	-	2.9	2x6 GN	1x6 GN		✓

Hot Carts

Mobile compact hot carts for the transportation of hot food ready to serve



Model PF6



Model PF12



Forced air heating and recirculation which gives energy saving efficiency, faster heat up times, quicker heat recovery times and an even distribution of heat without troublesome hot spots.

- Mobile bulk food hot holding cabinets
- Ideal when used in a modern hospital catering unit
- Excellent back up facilities for conveyor belt service bain-marie trolleys
- Easy food transportation when replenishing satellite serving stations
- Designed to hold hot food in 1/1 Gastronorm pans at optimum temperature
- When fitted with shelves can be used as a compact trolley for banquets
- Perfect for serving meals on time at conference meetings and gala events
- Can be used as a compact plated meal trolley as well as bulk food
- Versatile compact unit ideal when space is tight as they have a small footprint
- Three sizes available 6 pans, 12 pans and 20 pans
- Force air heating system ensures fast heat up times energy efficiencies
- The heating unit is easily removable for maintenance and cleaning
- Complete with a humidifier tray for maintaining the moisture content in food
- All stainless steel construction
- Heavy duty push handles
- Industrial type castors 2 fixed, 2 swivel braked
- Rigid bumper on chassis for protection
- Internal removable rack system for easy conveyance and cleaning
- Illuminated on off switch with energy regulated adjustable control
- Simplistic gravity door latch operation



Model PF20

MODEL	Weight kg	Dimensions L x D x H mm	No. of Shelves	Power Rating kw
PF6	70	730 x 730 x 880	6	1.0
PF12	89	730 x 730 x 1365	12	2.0
PF20	130	730 x 730 x 1800	20	2.0

Conveyor for Hotline Pellet System



Model HDTT32

Patient Meal Delivery Trolley
Multiple Tray Options
Suitable for Common Tray Sizes

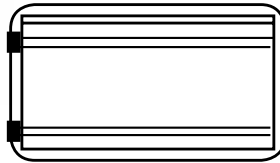

Models CBD

Basket Dispenser for Bowls

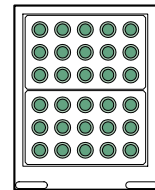

Model HTG3

3 Tier General Purpose
Support Trolleys

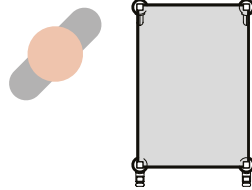

Basket Dispenser for Bowls

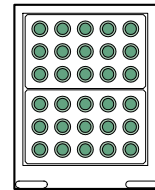

Model VCDC3

Round Cord Conveyor
Auto stop, variable speed.
Fitted with optional swivel/braked castors
& splash proof sockets underneath.



Model VCRB3

Flat Belt Conveyor
Auto stop, variable speed.
Fitted with optional swivel/braked castors
& splash proof sockets underneath.



Model VMCW2



Model FCHB2

Work Station for cutlery, napkins, menu cards etc.



Model VCP3E
Companion trolley with customised extended legs, containers for cutlery and **optional** hook on waste bin

Mobile cold well or Polar Well

High Heat Pellet/Plate Dispenser

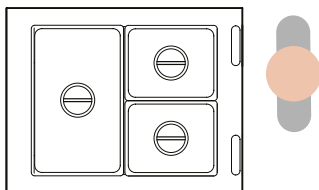
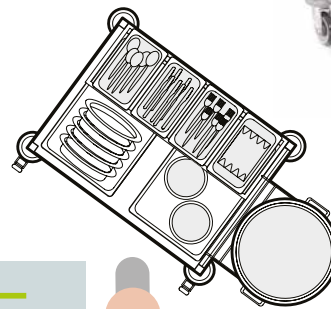
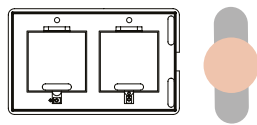
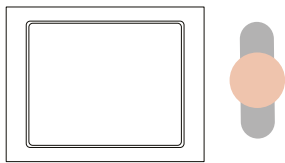

Mobile Fan Assisted heat Bains Marie Workstation

High Heat Pellet/Plate Dispenser

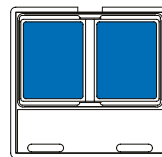

Tray Dispenser



Model CTD



Model VMBM2



Model FCHB2

Single Tray Conveyor System for Hotline, Regeneration or Chillogen



Model VTSL24GR



Model HTG3



Model VMCW2

Sandwich
Biscuit etc

Yoghurt
Ice Cream etc

General Purpose
Trolleys

Mobile cold well or
Polar Well

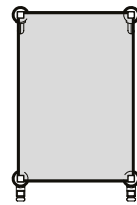
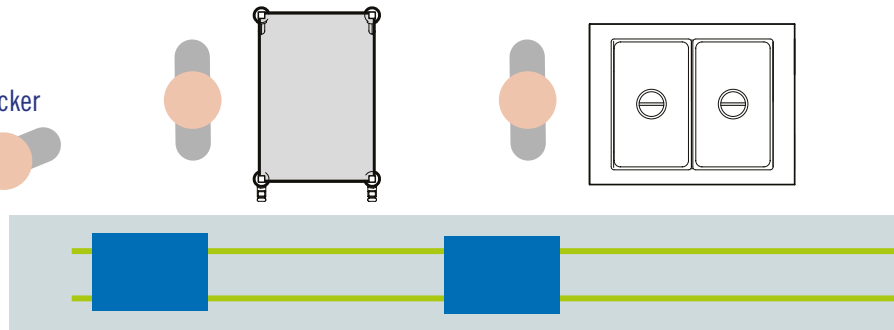
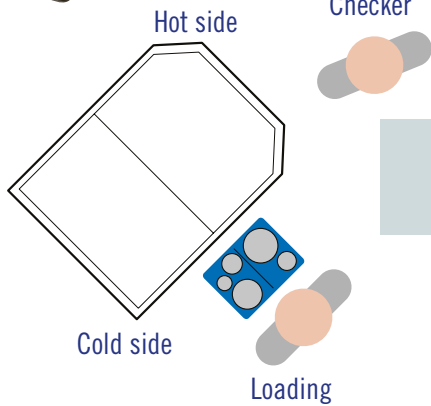

General Purpose
Trolleys

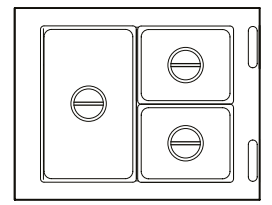

Mobile Fan Assisted heat
Bains Marie Workstation

Accessories

Hot Soup, Sauces
and Custard etc



Model HTG3



Model VDC3

Round Cord Conveyor

Auto stop, variable speed.
Fitted with optional swivel/braked castors
& splash proof sockets underneath.



Model VCRB3

Flat Belt Conveyor

Auto stop, variable speed.
Fitted with optional swivel/braked castors
& splash proof sockets underneath.



Model VPCT

Plate Covers



Model HP2

Warm or Cold Plates

Menu Cards
Napkins and Cutlery etc



Model VCP3E
Companion trolley with customised extended legs, containers for cutlery and **optional** hook on waste bin

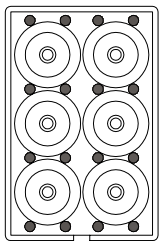

Heated or Ambient Plate Dispenser

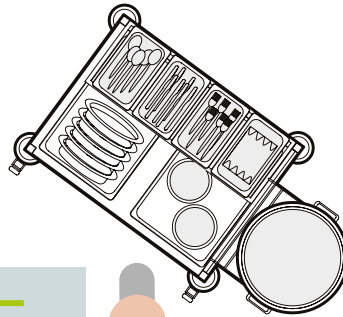
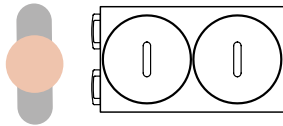

Initiator

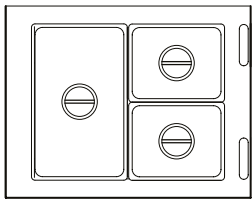

Mobile Fan Assisted heat Bains Marie Workstation

Main Hot Food

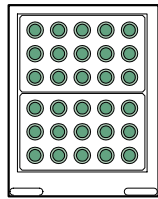

Basket Dispenser for Bowls

Bowls and Cups

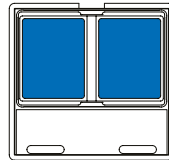

Tray Dispenser

Trays



Model VMBM2



Model CBD



Model CTD

Conveyors

Food Distribution Conveyor System

These specially designed food standard continuous conveyor systems are electrically powered and constructed with a splash proof satin finish stainless steel superstructure supported on robust tubular legs with adjustable feet for levelling off and floor fixing or with the optional swivel/braked castors if mobility is required. Fitted with a full length heavy duty bumper on both sides for protection when used with ancillary equipment.

Designed to be used as a part of a specific hospital grade foodservice system where reliability, ease of operation, and hygiene standards are of the utmost importance.

The silent smooth running anti-static conveyor units have a simplistic control panel at one end featuring a start and stop button, variable speed control, with the option of forward and reverse motion.

Emergency stop switches are located at each end of the unit. There is also a fundamental photo electric sensor fitted at the receiving end of the unit which automatically prevents trays clashing and breakages.

At each end of the conveyor belt there is 600mm long work area. This is essential at the start of the operation for tray set up, and placement of index cards. This area is of equal importance at the receiving end to aid trolley loading and transporting systems.

As safety and hygiene are paramount when operating a food conveyor system these units are open on the underside to ensure there is no build up of debris or spillage. Rubber cleaning scrapers and finger guards are fitted, automatically cleaning and maintaining belt safety.

Splash proof sockets if fitted are protected by R.C.B.O

The easily accessible splash proof distribution switch board and mains isolator are located at the end of the unit below the main control panel.

An extensive range of matching mobile equipment and accessories are available to create the perfect facility for conveyed food service. The range includes Starter stations, Plate dispensers, Base dispensers, Rack lifts, Tray lifts, Bain-marie, Refrigerated units, General purpose trolleys, Storage carts, Basket stackers, Tables, Ambient units, Mobile shelves, Workstations, Bulk food trolleys, Tray service trolleys and Tray transport trolleys.

Flat Belt Type

300mm wide seamless 'White' synthetic anti-static flat belt, can be used to smoothly transport individual items of crockery or as an integral part of a tray line operation. Optimising staff workload by simplifying handling while increasing productivity and maximising food service efficiency.



*Flat Belt Conveyor
Fitted with optional swivel/braked
castors & splash proof sockets.*

MODEL	Type	Dimensions L x D x H mm	Overall Length mm
VCRB3	Belt Conveyor	3000 x 550 x 900	1800
VCRB4	Belt Conveyor	4000 x 550 x 900	2800
VCRB5	Belt Conveyor	5000 x 550 x 900	3800
VCRB6	Belt Conveyor	6000 x 550 x 900	4800
VCRB7	Belt Conveyor	7000 x 550 x 900	5800
VCRB8	Belt Conveyor	8000 x 550 x 900	6800
VCRB9	Belt Conveyor	9000 x 550 x 900	7800

Round Cord Type

Parallel 15mm diameter seamless green coloured synthetic round cords run 220mm apart. Designed for maximum hygiene with minimum cleaning.

The cord type conveyor unit can transport various sizes of trays side-by-side, either longitudinally or lateral which depending on the length of the tray is not always possible with the flat belt type conveyor.



*Round Cord Conveyor
Fitted with optional swivel/braked castors
& splash proof sockets.*



Optional splash proof sockets



*Control panel & splash proof
distribution switch board*

MODEL	Type	Dimensions L x D x H mm	Overall Length mm
VCDC3	Cord Conveyor	3000 x 550 x 900	1800
VCDC4	Cord Conveyor	4000 x 550 x 900	2800
VCDC5	Cord Conveyor	5000 x 550 x 900	3800
VCDC6	Cord Conveyor	6000 x 550 x 900	4800
VCDC7	Cord Conveyor	7000 x 550 x 900	5800
VCDC8	Cord Conveyor	8000 x 550 x 900	6800
VCDC9	Cord Conveyor	9000 x 550 x 900	7800

Dispensers

High Temperature System

- Up to 60 minutes heat retention using the wax filled pellet system.
- Using a High Heat Pellet Dispenser is the only solution for ensuring pellets reach a minimum of 110°C.
- Stainless steel hinged lids prevents overloading and lowers operating costs by reduced heat loss. No covers to break or lose.
- Fan assisted high heat dispenser ensures every pellet and plate is dispensed at the correct temperature.
- Pellet Underliners are an essential component to protect patients and reduce heat loss. In addition the food underliner will protect cold food.
- Modern insulation materials used in the plate domes will guarantee food plated at 80°C will remain above 65°C for up to an hour.
- Old systems can be upgraded in stages by incorporating some of the components to assist budgetary constraints.



High Temperature Base and Plate Dispensers

Models VMBH Base Heater, VMPH Plate Heater, VMBPH Plate on Base Heater

These specially designed electrically powered mobile dispensers can be used to heat. • Special wax filled stainless steel bases to 110°C • Plates to 80°C • Or a combination of plate on base.

Compact lightweight units designed to be used as part of a specific hospital grade food service system. Simplistic controls with fan assisted heating. All dispensers are designed for easy maintenance and cleaning.

All stainless steel construction fitted with push/pull handles and fitted with four castors. Two fixed, two swivel with brakes. Tidy curly mains lead with plug park and heavy-duty corner bumpers. Complete with lock down lids. Fully insulated.



Forced air heating and recirculation which gives energy saving efficiency, faster heat up times, quicker heat recovery times and an even distribution of heat without troublesome hot or cold spots.

MODEL	Type	Weight kg	Dimensions L x D x H mm	Plate Size	Heating Time options	Plates/base per Tube	Average Temperature	Power Rating kw
VMPH	Ceramic Plates or Plastic Base	74	840 x 530 x 1025	9" (230mm)	135 mins	40	80°C	2.0
VMBPH	Plate on Metal Base Heater	74	840 x 530 x 1025	9" (230mm)	75 mins	19Plates/19Bases	90°C	2.9
VMBH	Metal Base Heater	74	840 x 530 x 1025	9" (230mm)	135 mins	40	110°C	2.9

Fan Assisted Mobile Dry Well Bains Marie Workstation

Model VMBM2, VMBM3, VMBM4

These specially designed electrically powered mobile Bainmarie units are used to store and transport hot pre-cooked food that is ready for serving.

Compact lightweight units designed to accommodate various combinations of interchangeable Gastronorm size containers up to 150mm deep. Maximises the use of limited space. Suitable for many applications but more specifically used as part of a hospital grade food service system.

Simplistic controls comprising an

illuminated on/off switch indicating power is on and an energy regulator controlling the fan assisted heating unit.

Removable heating unit for easy maintenance and cleaning. All stainless steel construction. Fitted with push/pull handles and 4 all swivel castors, two with brakes.

Tidy mains lead with plug park and heavy-duty corner bumpers. Gastronorm containers are supplied separately. Please see Price list. (DRY HEAT ONLY)



MODEL	Weight kg	Dimensions L x D x H mm	Capacity	Power Rating kw
VMBM2	33	850 x 665 x 900	2x1/1Gn	1.0
VMBM3	42	1175 x 665 x 900	3x1/1Gn	1.0
VMBM4	56	1505 x 665 x 900	4x1/1Gn	2.0

Mobile Cold Wells

Model VMCW2, VMCW3, VMCW4

These specially designed electrically powered mobile units with a 200 mm deep refrigerated well are used to store and transport chilled food that is ready for serving.

Compact lightweight units can be used to hold various types of chilled product.

Made to accommodate different combinations of interchangeable Gastronorm containers up to 150mm deep.

Suitable for many applications but more specifically used as part of a hospital grade food service system.

Simplistic controls comprising an on/off switch indicating power is on and a adjustable thermostat controlling the refrigeration.

The well has a drain valve radius internal corners with removable perforated trays for easy cleaning.

All stainless steel construction fitted with push/pull handles and 4 all swivel castors, 2 fitted with brakes.

Stainless Steel Hinged/Lift Off Well Cover.

Tidy mains cable with plug park and heavy duty corner bumpers.



MODEL	Weight kg	Dimensions L x D x H mm	Capacity	Power Rating kw
VMCW2	64	850 x 665 x 900	2x1/1Gn	0.3
VMCW3	74	1175 x 665 x 900	3x1/1Gn	0.3
VMCW4	84	1505 x 665 x 900	4x1/1Gn	0.3

Mobile Polar Wells

Model VMPW2, VMPW3, VMPW4

These specially designed ambient mobile units with a 200 mm deep well are used to store and transport chilled food that is ready for serving.

Food is kept chilled by E&R Moffat polar plates, which are placed in the base of the well.

Polar plates keep food chilled for 2 to 3 hours before use the polar plates are charged for 8 to 12 hours in a deep freeze if longer periods of operation are required extra polar plates can be charged and used in rotation.

Compact lightweight units can be used to hold various types of chilled product.

Made to accommodate different combinations of interchangeable gastronorm containers up to 150 mm deep.

Suitable for many applications but more specifically used as part of a hospital grade food service system.

The well has a drain valve radius internal corners.

All stainless steel construction fitted with push/pull handles and 4 all swivel castors, 2 fitted with brakes.

Stainless Steel Hinged/Lift Off Well Cover.

Heavy duty corner bumpers.



Polar plates must firstly be charged for 12 hours in a deep freeze. They are then placed inside the well where they give off a steady flow of cold air for approx 2 to 3 hours. Once used, other polar plates can then be substituted thus keeping the well cold.

MODEL	Weight kg	Dimensions L x D x H mm	Capacity
VMPW2	34	850 x 665 x 900	2x1/1Gn
VMPW3	44	1175 x 665 x 900	3x1/1Gn
VMPW4	54	1505 x 665 x 900	4x1/1Gn

Dispensers

Universal Heated Basket/Rack Dispenser

Model URD

Designed to hold 500mm square dishwash type baskets and racks [Baskets/Racks not included]



- Plates and various types of crockery can be stored in the baskets straight from the dishwasher.
- The Baskets are loaded on to the spring adjustable, self-levelling platform.
- Heavy duty stainless steel construction complete with all swivel castors, two with brakes
- Fitted push/pull handles and a removable Stainless steel lid.
- Radiated heat with factory set thermostatic control at 40C

MODEL	Weight kg	Dimensions Ext. L x D x H mm	Basket size L x D x H mm	Capacity Racks/Basket	Power rating kw
URD	40	680 x 610 x 1010	500 x 500 x 100	5	0.6

Universal Unheated/Heated Crockery Dispensers

Model UAD1&2 and UHD1&2

Designed for the storage and dispensing of any size or shape of plate, be it round, oval, square or designer shape, that can fit within a 305mm (12") square.



- Ideal for oval or square designer type plates
- Well proven elements/components provide evenly distributed heat
- Factory set thermostatic control at 40°C
- Interior finished in clinical bright polished stainless steel
- Exterior panels are durable Merlin grey plastic coated steel (stainless steel at extra cost)
- Complete with stainless steel lid
- Convenient facility for storing lids during service
- Heavy duty robust corner bumpers for protection
- Capacity approximately 75 plates per tube based on a standard 9" NHS style plate
- Heated models supplied with a 2 metre long cord complete with cable tidy and 13 amp plug for easy installation [13A 230V 50Hz]
- Simplistic easy adjustable spring systems allows repeated pop up plate presentation
- Fitted with 4 x 100mm diameter castors, 2 fixed and 2 swivel with brakes.

MODEL	Weight kg	Dimensions L x D x H mm	No. of Dispensers	Plate Diam mm/inches	Approx. Capacity
UAD1	24	480 x 465 x 900	Single	305/12	75
UAD2	40	480 x 750 x 900	Twin	305/12	150

• Note: Outer panels are Merlin Grey

MODEL	Weight kg	Dimensions L x D x H mm	Electrical supply	Power Rating kw	No. of Dispensers	Plate Diam mm/inches	Approx. Capacity
UHD1	26	480 x 465 x 900	13amp	0.6	Single	305/12	75
UHD2	42	480 x 750 x 900	13amp	1.2	Twin	305/12	150



Universal Tray Dispenser

Model UTD

Spring adjustable, self levelling tray dispenser, heavy duty stainless steel construction complete with all swivel castors, two with brakes and push/pull handles.



MODEL	Weight kg	Dimensions Ext. L x D x H mm	Tray size L x D mm	Capacity
UTD	30	660 x 560 x 890	550 x 380	100

Universal unheated Basket/Rack Dispenser

Model UBD

Self levelling dispenser for racks or baskets. Heavy duty stainless steel construction. Complete with all swivel castors, two with brakes and push/pull handles.

MODEL	Weight kg	Dimensions Ext. L x D x H mm	Basket size L x D x H mm	Capacity Racks/Basket
UBD	35	680 x 610 x 1010	500 x 500 x 100	5

Versilift Plate Dispenser

Models UP1, UP2, HP1, HP2

Stainless steel top and base. stainless steel outer panels for longer lasting looks. Each tube has four adjustable guides to enable it to take various size plates. The Moffat patented spring system is variable to accommodate different weights of plates. Heated models fitted with the Saharafan forced air heating system which is easily removed for cleaning/ maintenance and adjustable temperature control for fast and even heat. Complete with an ABS plastic cover to each heated tube (ambient models, cover extra). Fitted with 100mm dia castors - two swivel with brakes and 2 fixed.

Designed for the storage and dispensing of plates

- Pop-up plates, lift one off and the next one automatically moves up into position for lifting
- Capacity 75 plates approx per tube, depending on thickness
- Adjustable to suit 8" - 12" (200mm - 308mm) diameter plates
- Top, base and plate guides in stainless steel
- All heated models fitted with cable and plug for 13 amp supply.
- Heavy duty robust corner bumpers for extra protection.



Model HP1



Model HP2

MODEL	Weight kg	Dimensions L x D x H mm	Number of Dispensers	Plate Diam. mm	Plate Diam. inch	Approx. Capacity	Power Rating kw
UP1	28	485 x 525 x 1015	Single	203-305	8/12	75	-
UP2	42	485 x 800 x 1015	Twin	203-305	8/12	150	-
HP1	32	485 x 525 x 1015	Single	203-305	8/12	75	1.0
HP2	46	485 x 800 x 1015	Twin	203-305	8/12	150	2.0

Cantilever Basket

Dispenser Model CBD

Cantilever Tray Dispenser

Model CTD

These specially designed dispensers are equipped with a stainless steel Stacking Platform suitable for various types of trays. Compact heavy-duty cantilever design. Can accommodate up to 100 trays. Gastronorm, Euronorm and the moulded sectioned type. Removable lift off panel for easy access for spring adjustment maintenance and cleaning. All stainless steel construction. Fitted with push/pull handles and 4 all swivel castors, 2 with brakes and heavy duty corner bumpers.



MODEL	Weight kg	Dimensions L x D x H mm	Tray Size L x D mm	Basket Size L x D x H mm	Capacity Tray/Basket
CTD	50	605 x 635 x 950	To Suit Customer Tray size	-	100
CBD	60	755 x 635 x 950	-	500 x 500 x 75	8

Mobile Trolleys

Versigen Plate Cover Trolley

Model VPCT

Designed to hold standard covers for a 9" (230mm) plate. Cover Diameter 240mm



MODEL	Weight kg	Dimensions L x D x H mm	Capacity Racks/Basket
VPCT	28	870 x 570 x 900	approx 250 covers (depending on type of cover used)

Heavy Duty General Purpose Trolley

Model HT2, HT3, HT4, HTG2, HTG3, HTG4

The workhorse of the catering industry, the fetcher and carrier has so many uses from a food server to a clearing trolley. Uprights in 30mm square section stainless steel (type 304). Shelves manufactured from 1.2mm stainless steel (type 304) with radius bottom corners and 40mm raised lip fully around to retain load. Round stainless steel handle at both ends. All welded construction to form a heavy duty unit. 4 Revolving buffers fitted as standard. Complete with 125mm dia. swivel castors 2 with brakes.



Max load = 225kg

Max per shelf = 100kg

MODEL	Weight kg	Dimensions L x D x H mm	No. of Shelves	Max Load capacity in KG per unit
HT2	20	800 x 550 x 950	2	120
HT3	25	800 x 550 x 950	3	180
HT4	30	800 x 550 x 1250	4	180
HTG2	26	1050 x 550 x 950	2	120
HTG3	33	1050 x 550 x 950	3	180
HTG4	39	1050 x 550 x 1250	4	180

Tray/Basket Trolley

Model MTBT

An extremely compact unit for the storage of baskets or trays.



Model MTBT

Cutlery/Tray Trolley

Model CT5

Stainless steel construction with black side panels. Ten high level removable, for cleaning, round cutlery containers complete with all swivel castors, two with brakes.



Model CT5

Mobile Tray Stand

Model MTS

Satin smooth all stainless steel construction mounted on all swivel castors, two with brakes. Capable of transporting various sizes of trays or baskets.



Model MTS

Low Load Trolley

Model MLL

Designed to take racks or baskets and arranged to ensure positive stacking. The angular base frame locates the baskets and the handle arrangement forms an effective support for the stacked baskets.



Model MLL

MODEL	Weight kg	Dimensions L x D x H mm	Basket Size L x D x H mm	Capacity Racks/Basket
MTBT1	16	580 x 525 x 900	500 x 500 x 120	4
CT5	28	660 x 500 x 875	-	-
MTS1	14	600 x 600 x 900	-	-
MLL1	14	660 x 600 x 900	500 x 500	-

Beverage Trolley

Model VBT

Lightweight and robust, the Versigen Beverage Trolley is ideal for the service of all beverages Available in Mahogany (as shown), or in stainless steel.

Features

- Fitted with four castors, two fixed, two swivel with brakes
- 6 x cutlery dispensers
- 3 x 1/9 GN plastic containers ideal for sugar, spoons etc
- 1 x 1/3 GN plastic container for waste (inset into the worktop).
- 4 plastic bins to suit runners under worktop
- suitable for use with Carlise Beverage Dispensers (not supplied)



MODEL	Dimensions Ext. L x D x H mm	Capacity Basket
VBT	1040 x 620 x 1440	4

Note: Water Boilers/Liquid Dispensers are not included

Toast Warmer

Model TW1

Appliance for keeping toasted bread slices warm and crisp. Ideal for hospitals and health care facilities as part of a Beverage / Hydration trolley serving toast on the ward. Toast is kept warm between kitchen and bedside, facilitating hot toast for an entire ward.

The TW1 toast warmer can hold up to 30 slices of toast on twin racks for up to 45min at an ideal temperature until ready to serve. The racks are removable for easy cleaning and quick service. Complete with a removable hygienic crumb tray and full front hinged Perspex door.

Can also be used as part of a hotel breakfast service or any food outlet where high volume is required in a short period. Supplied with a 2 meter long cord set with moulded 13 amp plug for easy installation [13A 230v 50Hz]



MODEL	Weight kg	Dimensions Ext. L x D x H mm	Power rating kw
TW1	7	235 x 235 x 410	0.35

Ward Beverage/Breakfast System

Model BBT

The mobile ward service trolley allows beverages, refreshments and light meals to be served to patients and visitors at the bed side or in lounges and other communal areas. Perfect for use in busy hospitals retirement homes and various other types of healthcare facilities.

Easy to manoeuvre and simple to use and keep clean, a practical hygienic and versatile design with a wide range of options and features, multiple drawers and runners, for holding baskets pans and ingredient containers etc. Crockery carried on board.

- Easy to keep clean
- Light and easy to manoeuvre
- Corner bumper protection
- Solid stainless steel top
- Drawer complete with 4 section cutlery box
- Drawer complete with Polypropylene pan
- Robust and ergonomic galley rail on three sides
- Discreet pan for cleaning cloth / spray
- Push pull handles
- Fitted with four castors, two fixed, two swivel with brakes
- Wide choice of colour front and end panels
- Holds up to four dish wash baskets [500mm sq type]



MODEL	Weight kg	Max Weight Loaded	Dimensions Ext. L x D x H mm	Height to work top mm
BBT	50	150	1050 x 620 x 1440	900

Optional Extras

- BTB** 1 off Crockery baskets 500 x500 type [Trolley can hold up to 4 Baskets]
- BTWB** 1 off 10 litre Water Boiler Complete with retaining base and built in removable drip tray
- TW1** 30 slice Toast warmer
- BCC** 4 off Cereal containers with drawer adaptor

- BID** 2 off Ingredient dispensers [coffee sugar etc]
- BES** Fold Down End Shelf with galley rail
- BESW** Fold Down End Shelf with Waste bag aperture
- BDL** Lockable drawers / dispensers [per lock]

Ambient TT Range

Tray transport trolleys for storing meal components on Gastronorm or Euronorm trays. These robust trolleys are fully insulated, have a bright polished stainless steel interior and plastic coated outer panels.

The standard outer panel colour is goose wing grey with other colour choices available on request. Featuring recessed push pull handle bars on both sides and double-wing doors that can be opened 270°, doors lock via a transport “J” clip latch. The Interior is split in two for easy cleaning, with removable support ledge frames and L-shaped angles, adjustable for 10/16/20/24/30GN or 10/16/20/24/30EN standard trays, in a portrait configuration. Suitable for hooking up to a delivery transport system with the optional tow bar. Additionally the chassis design allows for a specified automatic trolley transport option. Complete with corner buffers and fitted with four heavy duty castors two fixed and two all swivel with brakes.



Model MTT10



Model MTT20

MTT Trolleys

Features:

- Hinged doors open 270°.
- Fully insulated
- Simplistic J clip hold doors closed during transport.
- Inset push pull handle bars to both ends.
- Drain hole in base to compliment cleaning.
- Stainless steel runners with anti-tilt channel.
- Removable support racks allow easy cleaning access.
- Recessed top for conveying additional boxed items.
- 160mm smooth running rubber type wheels.
- Two fixed castors, two all swivel with brakes.
- Adjustable design allows the internal racks to accommodate either Gastronorm 1/1 or Euronorm trays.
- Heavy duty corner buffers.

Options

- Trays
- Tow bar
- I/D card holder
- Coloured outer panels



J clip to hold doors closed during transit



Model MTT30

Model MTT24

Model MTT16

MODEL	Weight kg	Dimensions L x D x H mm	Shelf Pitch mm	Maximum Tray Space mm
MTT10	110	1095 x 715 x 925	115	GN = 560 x 335 EN = 560 x 380
MTT16	120	1095 x 715 x 1270	115	GN = 560 x 335 EN = 560 x 380
MTT20	130	1095 x 715 x 1500	115	GN = 560 x 335 EN = 560 x 380
MTT24	145	1566 x 715 x 1270	115	GN = 560 x 335 EN = 560 x 380
MTT30	165	1566 x 715 x 1500	115	GN = 560 x 335 EN = 560 x 380

Standard Gastronorm Tray dimensions are 530 x 325
 Standard Euronorm Tray dimensions are 530 x 370

Colour Finishes

The unique design of our Versigen trolley range enables a vast array of colours and finishes to be supplied, shown below are a sample of our standard range. Image shown is in Buttermilk. Standard colour is Dobel Grey

Metallics, wood and natural textures are also available on request. You may select from this wide range, or you can colour code the trolleys by varying the colour for each ward, the possibilities are limitless.



Your Trolleys can be enhanced even more with additional coachlines and transfers available at extra cost.



Coachlines and transfers are also available at extra cost.



Black



Merlin Grey



Gooswing Grey



Navy



Regatta Blue



Wedgewood Blue



Academy Maple



Ocean Blue



Forest Green



Vandyke Brown



Terracotta



Poppy Red



Aztec Yellow



Lampre Beech



Dobel Grey



Buttermilk



Bamboo



White



Stainless Steel



Mahogany

Whilst every effort is made to represent the true colours of our panels these must be used as a guide only. True colour samples are available upon request.



**The Catering Equipment
Company**



E & R Moffat Ltd.

Bonnybridge FK4 2BS
Scotland

T +44 (0) 1324 812272
sales@ermoffat.co.uk



www.ermoffat.co.uk